





































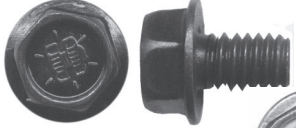
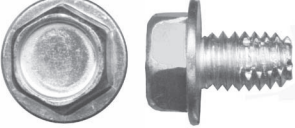

Hex Washer Head Screws

	Number	Price	Description
	FA 4642 H	\$ 0.45	8-32x3/4 Ind. HWH 18-8, S.S.
	FA 4349 A	\$ 0.45	8-32x3/4 Ind. HWH Type F Slotted, Zinc
	FA 4601 A	\$ 0.45	8-32x3/4 Ind. HWH Type F 1/4 A/F, Zinc
	FA 3353 A	\$ 0.40	8-32x3/4 Ind. HWH Type 23, Zinc
	FA 4643 H	\$ 0.50	8-32x1 Ind. HWH 18-8, S.S.
	FA 2744 N	\$ 0.45	8-32x1 Ind. HWH, Nickel Type 23
	FA 4644 H	\$ 0.50	10-24x3/8 Ind. HWH 18-8, S.S.
	FA 4754 H	\$ 0.50	10-24x3/8 Ind. HWH Serrated 18-8, S.S.
	FA 4351 A	\$ 0.40	10-24x3/8 Ind. HWH Type F, Zinc
	FA 4757 H	\$ 0.75	10-32x3/8 Ind. HWH Serrated, 18-8, S.S.
	FA 2751 N	\$ 0.35	10-24x1/2 Ind. HWH Pointed, Nickel
	FA 4946 A	40.45	10-24x1/2 Ind. HWH, Zinc
	FA 4645 H	\$ 0.75	10-24x1/2 Ind. HWH 18-8, S.S.
	FA 4755 H	\$ 0.70	10-24x1/2 Ind. HWH Serrated 18-8, S.S.
	FA 4352 A	\$ 0.45	10-24x1/2 Ind. HWH Type F, Zinc
	FA 2636 B	\$ 0.50	10-24x1/2 Ind. HWH Type 23, Black
	FA 2636 A	\$ 0.50	10-24x1/2 Ind. HWH Type 23, Zinc
	FA 4758 H	\$ 0.75	10-32x1/2 Ind. HWH Serrated 18-8, S.S.
	FA 4372 A	\$ 0.50	10-24x5/8 Ind. HWH, Zinc
	FA 4759 H	\$ 0.75	10-32x5/8 Ind. HWH Serrated 18-8, S.S.
	FA 3299 A	\$ 0.50	10-24x3/4 Ind. HWH, Zinc
	FA 4647 H	\$ 0.85	10-24x3/4 Ind. HWH 18-8, S.S.
	FA 4771 B	\$ 0.55	10-24x3/4 Ind. HWH, Serrated, Black
	FA 4756 H	\$ 0.60	10-24x3/4 Ind. HWH Serrated 18-8, S.S.
	FA 1688 A	\$ 0.55	10-24x3/4 Ind. HWH Type F, Zinc
	FA 4760 H	\$ 0.60	10-32x3/4 Ind. HWH Serrated, 18-8, S.S.
	FA 4648 A	\$ 0.65	10-24x1" Ind. HWH, Zinc
	FA 4648 H	\$ 0.75	10x24-1" Ind. HWH 18-8, S.S.
	FA 4947 A	\$ 0.65	10-32x1" Ind. HWH, Zinc
	FA 4761 H	\$ 0.75	10-32x1" Ind. HWH Serrated 18-8, S.S.

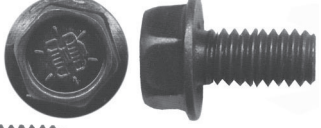
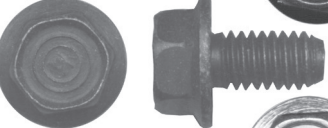
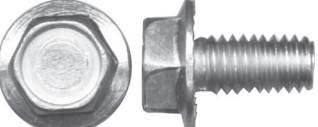
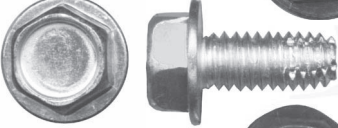
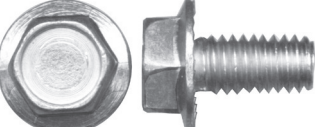
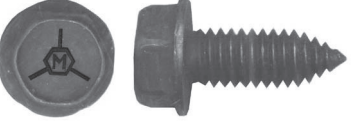
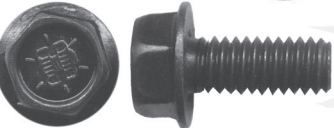
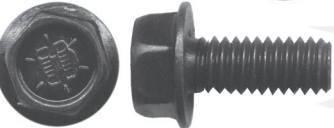
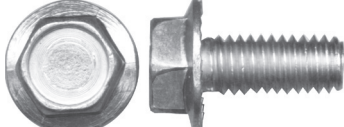
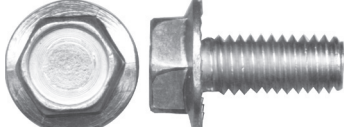
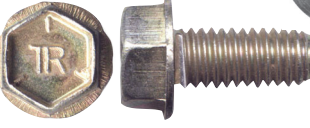



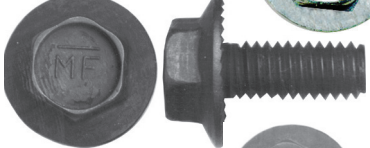
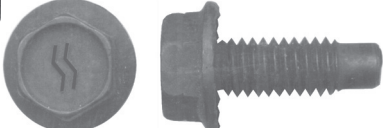



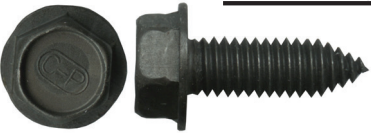

Hex Washer Head Screws

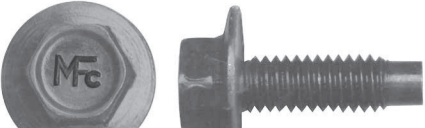
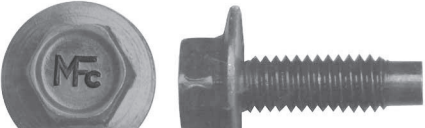
	Number	Price	Description
	FA 4649 H	\$ 0.95	1/4-20x3/8 HWH, 18-8 S.S.
	FA 4369 A	\$ 0.50	1/4-20x1/2 HWH w/1/2 Flange, Zinc
	FA 4369 B	\$ 0.55	1/4-20x1/2 HWH w/1/2 Flange, Blk
	FA 4369 B8	\$ 0.65	1/4-20x1/2 HWH w/1/2 Flange G8, Blk
	FA 4650 H	\$ 1.20	1/4-20x1/2 HWH, 18-8 S.S.
	FA 4772 B	\$ 0.60	1/4-20x1/2 HWH w/1/2 Flange Ser., Blk
	FA 4370 A	\$ 0.55	1/4-20x1/2 HWH w/1/2 F. Type 23, Zinc
	FA 4371 A	\$ 0.55	1/4-20x1/2 HWH w/1/2 F. Type F., Zinc
	FA 4651 H	\$ 1.35	1/4-20x5/8 HWH, 18-8 S.S.
	FA 1030 B	\$ 0.65	1/4-20x5/8 HWH w/5/8 Flange, Blk
	FA 1030 B8	\$ 0.85	1/4-20x5/8 HWH w/5/8 Flange G8, Blk.
	FA 4098 A	\$ 0.50	1/4-20x3/4 HWH w/1/2" F. Zinc
	FA 4652 H	\$ 1.35	1/4-20x3/4 HWH 18-8 S.S.
	FA 4098 B8	\$ 0.65	1/4-20x3/4 HWH w/1/2" F. G8, Black
	FA 4544 H	\$ 1.35	1/4-20x3/4 Slotted HWH 18-8 S.S.
	FA 1016 B5	\$ 0.95	1/4-20x7/8 HWH Boltw /Loose 5/8 Nylon Washer G5, Blk.
	FA 2757 A	\$ 0.50	1/4-20x1 HWH 5/16H, Zinc
	FA 4797 B	\$ 0.60	1/4-20x1 Ind. HWH
	FA 4653 H	\$ 1.50	1/4-20x1 HWH 18-8 S.S.
	FA 4460 B8	\$ 0.75	1/4-20x1" HWH w/1/2" F. G8, Black
	FA 4912 B	\$ 0.70	1/4-20x1-1/4 HWH Type F, 1/2F., Blk Ox
	FA 4441 A	\$ 0.55	1/4-20x1-1/4 HWH 3/8H, 1/2F., Zinc
	FA 4441 B8	\$ 0.70	1/4-20x1-1/4 HWH 3/8H, 1/2F. G8, Blk
	FA 4654 H	\$ 1.50	1/4-20x1-1/4 HWH 18-8 S.S.
	C6029144	\$ 0.85	1/4-20x1-1/2 HWH w/5/8 W. Type 23, Blk- Disc.
	FA 4773 B	\$ 0.70	1/4-20x1-1/2 HWH w/1/2 F. Serrated, Blk.
	FA 3384 A	\$ 0.60	1/4-20x1-1/2 HWH, Zinc
	FA 3384 B8	\$ 0.75	1/4-20x1-1/2 HWH, G8, Black
	FA 4781 H	\$ 1.50	1/4-20x1-1/2 HWH, 18-8 S.S.
	FA 989 B	\$ 0.75	1/4-20x1 1/2 HWH w/5/8 F., Blk
	FA 4920 B	\$ 1.10	1/4-20x2 HWH Slotted, Blk

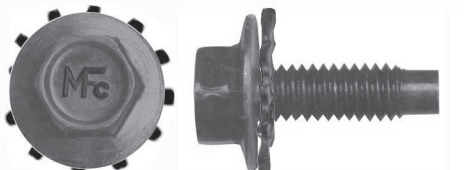
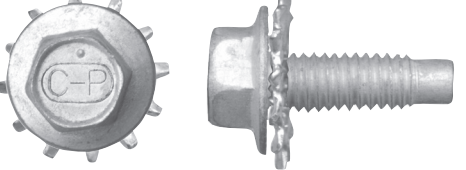
Hex Washer Head Screws

	FA 1007 B8	\$ 1.30	5/16-18x1/2 HWH w/5/8 F.G8,Blk
	FA 4353 A	\$ 0.90	5/16-18x1/2 HWHw/5/8 F. Type F, Zinc
	FA 4774 B	\$ 0.80	5/16-18x1/2 HWH Serrated 11/16 F.,Blk
	FA 3196 B8	\$ 0.90	5/16-18x5/8 HWH w/11/16" F.G8, Blk
	FA 4775 B	\$ 0.85	5/16-18x5/8 HWH w/11/16" F. Ser, Blk
	FA 4383 A	\$ 0.60	5/16-18x5/8 HWH w/3/4F., Zinc
	FA 4354 A	\$ 0.70	5/16-18x3/4 HWH w/5/8 F. Type F, Zinc.
	FA 4620 A	\$ 0.70	5/16-18x3/4 HWH w/5/8 F. TR-3, Zinc
	FA 1019 B5	\$ 0.85	5/16-18x13/16 HWH w/11/16 F. G5, Blk.
	FA 3677 A	\$ 0.70	5/16-18x3/4 HWH w/11/16" F.G8 ,Zinc
	FA 3677 B8	\$ 0.80	5/16-18x3/4 HWH w/11/16" F.G8 ,Blk.
	FA 4776 B	\$0.80	5/16-18x3/4 HWH Serrated 11/16 F., Blk
	FA 4384 A	\$ 0.65	5/16-18x3/4 HWH Serated, Zinc
	FA 4545 D5	\$ 0.75	5/16-18x3/4 HWH 11/16 F. G5, Dic
	FA 4610 A5	\$ 0.95	5/16-24x3/4 HWH w/11/16 F. Serated G5, Zinc
	FA 994 B	\$1.15	5/16-18x3/4 HWH w/13/16 F., Blk.
	FA 4240 K	\$ 0.80	5/16-24x3/4 HWH w/13/16 F.Serated, Cad.
	FA 4393 B	\$ 0.85	5/16-18x3/4 HWH w/13/16 F., Blk.- Disc.
	FA 3583 B	\$ 0.70	5/16-18x7/8 HWH w11/16" F. D.P., Blk.
	FA 4696 D5	\$ 0.75	5/16-18x7/8 HWH w11/16" F. G5 Dic.

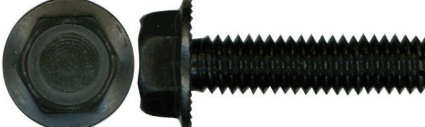
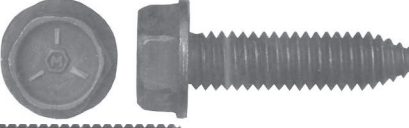
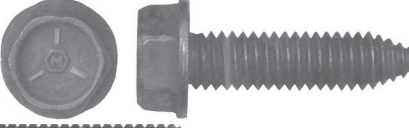
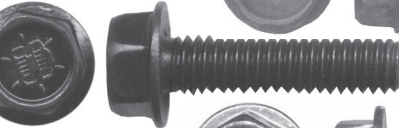
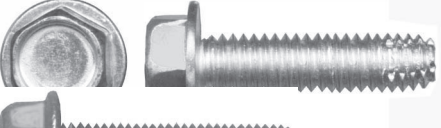

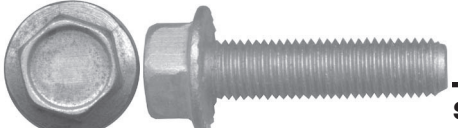

Hex Washer Head Screws

	FA 1008 B \$ 0.80	5/16-18x1 HWH w/5/8 Flange Pointed, Blk.
	FA 4355 A \$ 0.75	5/16-18x1 HWH w/5/8 F. Type F, Zinc
	FA 4210 B8 \$ 0.95	5/16-18x1 HWH w/3/4 Flange G8, Blk.
	FA 4847 A5 \$ 0.85	5/16-18x1 HWH w/11/16 F., G5, Zinc
	FA 995 B \$ 0.90	5/16-18x1 HWH w/13/16 F., Blk.
	FA 997 K \$ 1.05	5/16-18x1 HWH w/13/16 F., #1 Cad.
	FA 4015 B \$ 1.00	5/16-18x1 HWH/Star Washer, Black this washer is removeable
	FA 4016 K \$ 1.30	5/16-18x1 HWH/Star W., #1 Cad. this washer is removeable
	FA 4611 A5 \$ 0.80	5/16-24x1 HWH w/11/16" F. Serated G5, Zinc
	FA 4777 B \$ 0.95	5/16-18x1 HWH w/11/16" Flange Ser., Blk.
	FA 1002 B \$ 0.95	5/16-24x1 HWH w/13/16" Flange, Blk.
	FA 4778 B \$ 1.05	5/16-18x1-1/4 HWH w/11/16" F. Ser., Blk.
	FA 4848 A5 \$ 0.90	5/16-18x1-1/4 HWH w/11/16" F. Ser., G5, Zinc
	FA 1020 B5 \$ 0.75	5/16-18x1 1/4 HWH w/11/16 F. G5 , Blk.
	FA 4453 B8 \$ 1.10	5/16-18x1 1/4 HWH w/11/16 F. G8 , Blk.
	FA 4356 A \$ 0.80	5/16-18x1-1/4 HWH w/5/8 F. Type F, Zinc
	FA 4241 A \$ 0.75	5/16-24x1-1/4 HWH w/11/16F., Zinc
	FA 4261 K \$ 0.70	5/16-24x1-1/4 HWH w/11/16F., Cad.

Hex Washer Head Screws

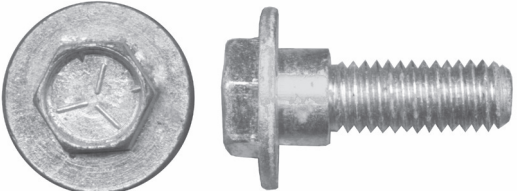
	Number	Price	Descriptio
	FA 1021 B	\$ 0.75	5/16-18x1-1/2 HWH w/11/16 F., Blk.
	FA 4779 B	\$ 1.05	5/16-18x1-1/2 HWH w/11/16 F.Ser., Blk.
	FA 4454 B8	\$ 1.20	5/16-18x1-1/2 HWH w/11/16 F.G8, Blk.
	FA 4769 B8	\$ 1.25	5/16-18x1-3/4 HWH w/11/16 F.G8, Blk.
	FA 1004 B	\$ 0.80	3/8-24x5/8 HWH w/29/32 Flange, Blk.
	FA 4770 B8	\$ 1.35	3/8-18x5/8 HWH w/13/16 Flange G8, Blk.
	FA 4780 B	\$ 1.15	3/8-18x3/4 HWH w/13/16 Flange, Blk.
	FA 4357 A	\$ 0.95	3/8-16x3/4 HWH w/3/4 F, Type F, Zinc
	FA 4455 B8	\$ 1.80	3/8-16x3/4 HWH w/3/4 F. G8, Blk.
	FA 4358 A	\$1.15	3/8-16x1 HWH /3/4" Flange Type F, Zinc
	FA 4456 B8	\$ 2.00	3/8-16x1 HWH w/3/4 F. G8,Blk.
	FA 1010 A5	\$ 0.95	3/8-16x1 1/8 HWH w/25/32 F. G5, Zinc
	FA 4365 A	\$ 1.30	3/8-16x1-1/4 HWH w/13/16 F.Type F, Zinc

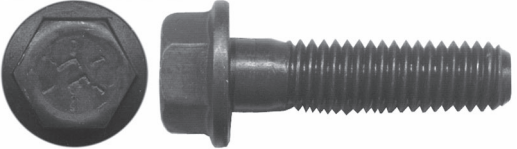
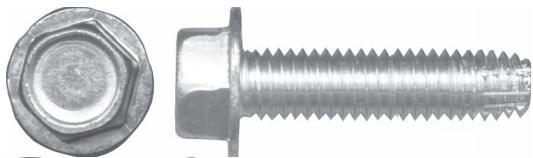
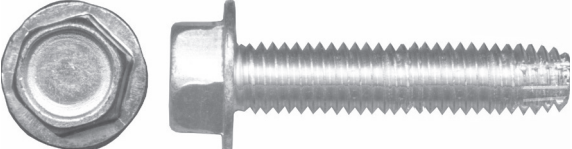
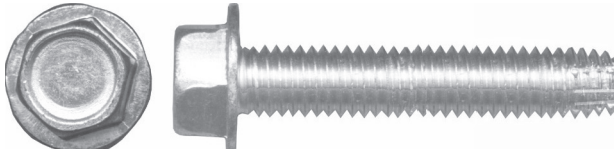
Hex Washer Head Screws

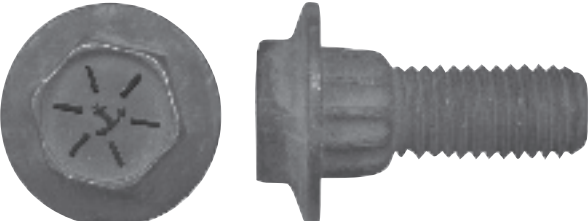
	Number	Price	Description
	FA 4457 B8	\$ 2.00	3/8-16x1-1/4 HWH w/3/4 F. G8, Blk.
	FA 3629 K5	\$ 1.75	3/8-16x1.26 HWH w/1" F. w/1/2x1/2" Shoulder G5, Cad
	FA 3539 B5	\$ 1.00	3/8-16x1-3/8 HWH G5, Black,
	FA 4458 B8	\$ 1.20	3/8-16x1-1/2 HWH w/3/4 F. G8, Blk.
	FA 4366 A	\$ 1.30	3/8-16x1-1/2 HWH w/13/16 F.Type F, Zinc
	FA 4367 A	\$ 1.55	3/8-16x1-3/4 HWH w/13/16 F.Type F, Zinc
	FA 4368 A	\$ 1.60	3/8-16x2 HWH w/13/16 F.Type F, Zinc
	FA 3660 A5	\$ 2.95	3/8-16x1-7/8 HWH, G5 GM Starter Bolt
	FA 4904 B8	\$ 2.75	Frame Bolt 1/2-13x1-1/4 Hex Washer Head with 1" OD Flange Grade 8, Black
	FA 2001 B8	\$ 2.75	Bumper Arm to Frame Bolt, 1/2-13x1-3/8 HWH w/3/8 Shoulder G8, Blk. - Disc

Hex Washer Head Screws

	Number	Price	Description
	FA 1999 A	\$ 0.30	4.21-1.41MMx11MM HWH-Phillips 10MM F., Zinc
	FA 4027 B	\$ 0.35	M4.2-1.41x13MM w/19 MM F. 7MM A/F Type 25, Blk
	FA 3409 B	\$ 0.40	8x5/8 H/L w/9/16W.(4.2-1.41x16MM w/12MM.W)
	FA 3364 B	\$ 0.60	M4.2-1.41x16MM H/L w/17MM W. w/Sho., Blk.
	FA 4925 A	\$ 0.60	M6-1.0x10 Din 6921 Class 8.8 MM HWH, Zinc
	FA 4068 B	\$ 1.10	M6-1.0x16 Din 6921 Class 10.9 MM HWH, Blk.
	FA 4942 A	\$ 0.85	M6-1.0x12MM w/14MM Fl.Gr 10.9 MM, Zinc
	FA 4064 B	\$ 1.50	M6-1.0x20MM HWH w/12MM F. Gr. 9.8, Blk.
	FA 4926 B	\$ 1.10	M6-1.0x20 Din 6921 Class 10.9 MM HWH, Blk.
	FA 2654 B	\$ 0.75	M6-1.0x20MM HWH w/14MM Flange Knurl Sho, Blk
	FA 4923 B	\$ 1.10	M6-1.0x25 Din 6921 Class 10.9 MM HWH, Blk.
	FA 4924 B	\$ 1.10	M6-1.0x30 Din 6921 Class 10.9 MM HWH, Blk.
	FA 2024 B	\$ 0.70	7.9MMx1.59x20MM HWH Bolt Hi-L0 Type 25, Blk.
	FA 4069 B	\$ 1.40	M8-1.25x16MM HWH, Blk.
	FA 4063 B	\$ 1.55	M8-1.25x20MM Din 6921 Class 10.9 HWH, Blk.
	FA 4927 A	\$ 0.60	M8-1.25x25 Din 6921 Class 8.8 MM HWH, Zinc
	FA 4043 B	\$ 1.55	M8-1.25x25MM Din 6921 Class 10.9 HWH, Blk.
	FA 4928 A	\$ 2.00	M10-1.5x20MM Din 6921 Class 8.8 HWH, Zinc